

INSTALLATION MANUAL

CAUTION:

- Potential hazard of glass particles if lamp ruptures. Please have an EIKI Authorized Dealer or Service Center replace lamp if rupture occurs.
- Do not remove the lamp unit directly after operation of the projector. The lamp may be extremely hot. Wait at least one hour after the power cord is disconnected to allow the surface of the lamp unit to fully cool before removing the lamp unit.

- It is recommended that the lamp be replaced when the remaining lamp life becomes 5% or less, or when you notice a significant deterioration in the picture and color quality. The lamp life (percentage) can be checked with the on-screen display.

Hg LAMP CONTAINS MERCURY For State Lamp Disposal Information
www.lamprecycle.org or 1-800-242-3454

U.S.A. ONLY

Removing and Installing the Lamp Unit

Warning!

- Do not remove the lamp unit from the projector right after use. The lamp and parts around the lamp will be very hot and may cause burn or injury.

Info

- Make sure the lamp unit is removed using the handle. Make sure the glass surface of the lamp unit or the inside of the projector are not touched.
- To avoid injury to yourself and damage to the lamp, make sure you carefully follow the steps below.
- Do not loosen other screws except for the lamp unit cover and lamp unit.

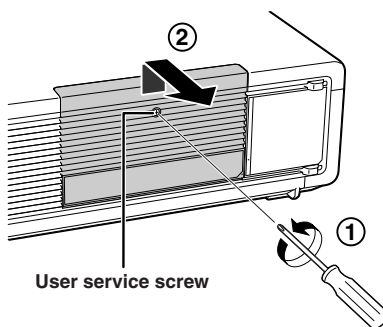
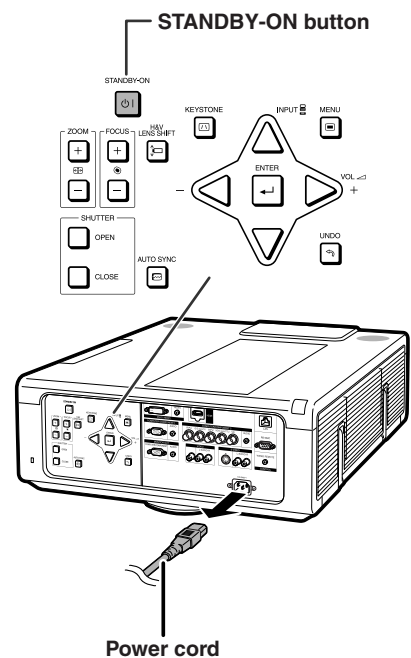

1 Press **STANDBY-ON** on the projector or on the remote control to put the projector into standby mode.

- Disconnect the power cord and unplug the power cord from the AC socket after the cooling fan stops.
- The cooling fan may continue to run for a while even after the power cord is removed.
- Leave the lamp until it has fully cooled down (about 1 hour).

2 Remove the lamp unit cover.

- Loosen the user service screw (1) that secures the lamp unit cover. Remove the lamp unit cover to slide it in the direction of the arrow (2).

3 Remove the lamp unit.

- Loosen the securing screws (two for each lamp) from the lamp unit. Hold the lamp unit by the handle and pull it in the direction of the arrow. At this time, keep the lamp unit horizontal and do not tilt it.

4 Insert the new lamp unit.

- Fully insert the lamp unit into the lamp unit compartment. Press the handles back to their positions, and tighten the securing screws.

5 Replace the lamp unit cover.

- Slide the lamp unit cover to the position where the indicator "▶" of the lamp cover unit and the "◀" of the projector will meet to close the cover. Then tighten the user service screw to secure the lamp unit cover.

Securing screws

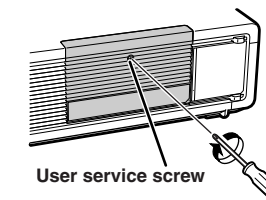
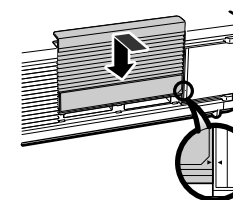
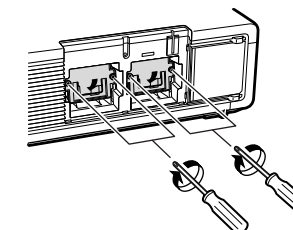
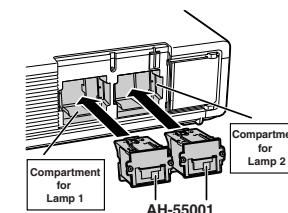
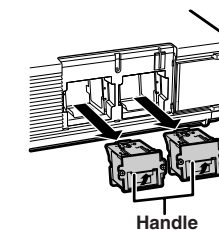
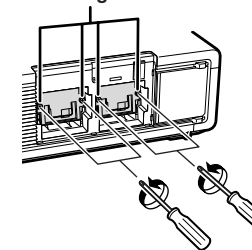

Info

- If the lamp unit and lamp unit cover are not correctly installed, the power will not turn on, even if the power cord is connected to the projector.

Resetting the Lamp Timer

Reset the lamp timer after replacing the lamp.

Info

- Make sure to reset the lamp timer only when replacing the lamp. If you reset the lamp timer and continue to use the same lamp, this may cause the lamp to become damaged or explode.

1 Connect the power cord.

- Plug the power cord into the AC socket of the projector.

2 Reset the lamp timer.

For Lamp 1

- When you reset the timer, while simultaneously holding down ◀, ▼ and **ENTER**, press **STANDBY-ON** on the projector.
- "LAMP1 0000H" is displayed, indicating that the lamp timer is reset.

For Lamp 2

- When you reset the timer, while simultaneously holding down ▶, ▼ and **ENTER**, press **STANDBY-ON** on the projector.
- "LAMP2 0000H" is displayed, indicating that the lamp timer is reset.

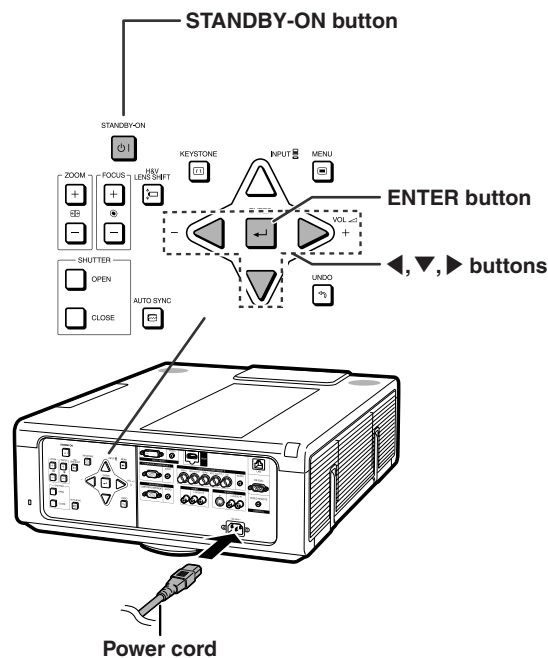

DEUTSCH

Für Anweisungen in Ihrer Sprache siehe Benutzerhandbuch im PDF-Format auf der mit dem Projektor mitgelieferten CD-ROM.

FRANÇAIS

Pour des instructions dans votre langue, reportez-vous au mode d'emploi PDF contenu dans le CD-ROM fourni avec le projecteur.

ESPAÑOL

Para recibir instrucciones en su idioma, consulte el manual de manejo PDF que se encuentra en el CD-ROM suministrado con el proyector.

ITALIANO

Per ricevere istruzioni nella propria lingua, fare riferimento al manuale d'uso in formato PDF incluso nel CD-ROM fornito con il proiettore.

PORTUGUÊS

Para instruções no seu idioma, consulte o manual de operação em PDF contido no CD-ROM fornecido com o projetor.

日本語

日本語の説明につきましては、プロジェクター本体に付属の取扱説明書をご覧ください。