

EIKI

PORTABLE LIQUID CRYSTAL PROJECTOR

MODEL **LC-100**

INSTRUCTION MANUAL

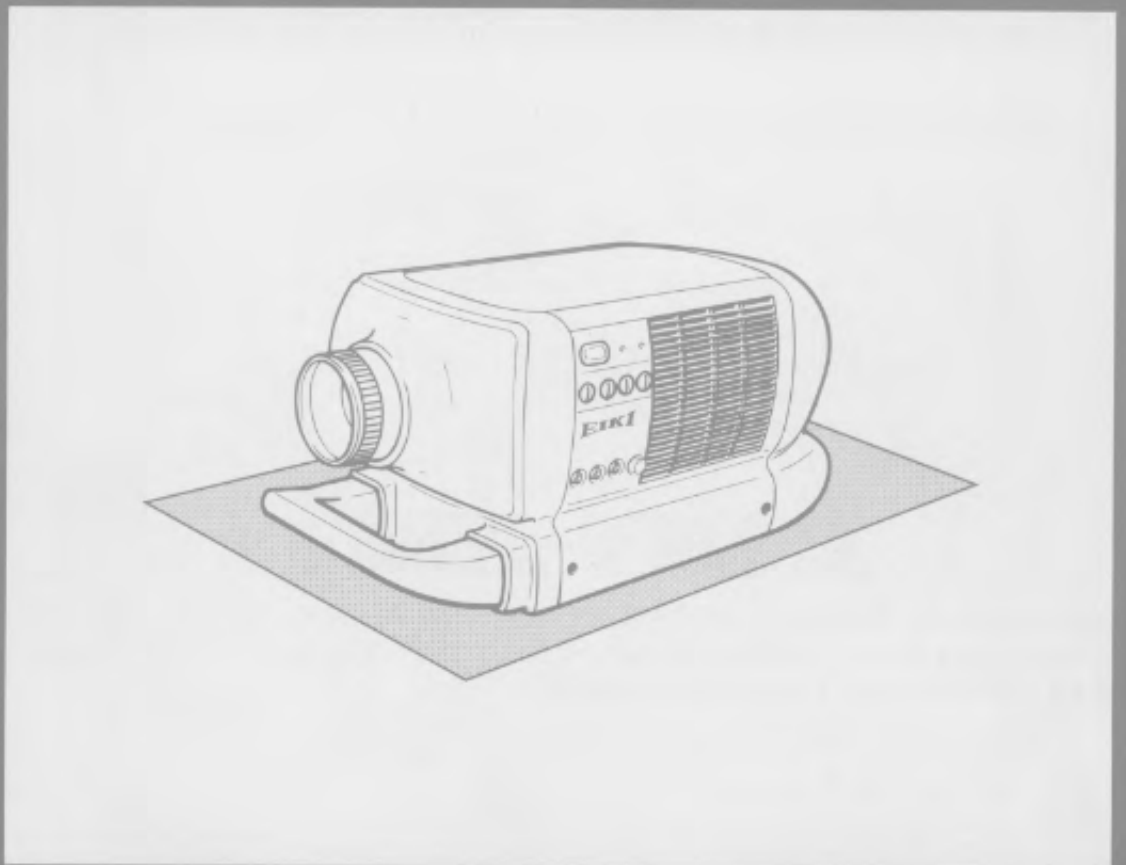

Thank you for purchasing the EIKI portable liquid crystal projector model LC-100.

To get the maximum performance, please read this instruction manual carefully before using the projector.

After reading it, store it in a safe place so you can refer to it when necessary.

INFORMATION TO THE USER

NOTE : This equipment has been tested and found to comply with the limits for a Class A digital device, pursuant to Part 15 of the FCC Rules. These limits are designed to provide reasonable protection against harmful interference when the equipment is operated in a commercial environment. This equipment generates, uses, and can radiate radio frequency energy and, if not installed and used in accordance with the instruction manual, may cause harmful interference to radio communications. Operation of this equipment in a residential area is likely to cause harmful interference in which case the user will be required to correct the interference at his own expense.

SAFETY PRECAUTIONS

WARNING:

TO REDUCE THE RISK OF FIRE OR ELECTRIC SHOCK, DO NOT EXPOSE THIS APPLIANCE TO RAIN OR MOISTURE.

The LC color video projector has a polarized AC line plug. This is a safety feature to be sure that the plug will fit into the power outlet. Do not defeat this safety feature.

Intense light source. Do not stare directly into the projection lens as possible eye damage could result. Be especially careful that children do not stare directly into to the beam.

If the LC color video projector will not be used for an extended time, unplug the LC color video projector from the power outlet.

READ AND KEEP THIS OWNER'S INSTRUCTION MANUAL FOR LATER USE.

	CAUTION RISK OF ELECTRIC SHOCK DO NOT OPEN	
CAUTION: TO REDUCE THE RISK OF ELECTRIC SHOCK, DO NOT REMOVE COVER (OR BACK). NO USER-SERVICEABLE PARTS INSIDE. REFER SERVICING TO QUALIFIED SERVICE PERSONNEL.		
	THIS SYMBOL INDICATES THAT DANGEROUS VOLTAGE CONSTITUTING A RISK OF ELECTRIC SHOCK IS PRESENT WITHIN THIS UNIT.	
		THIS SYMBOL INDICATES THAT THERE ARE IMPORTANT OPERATING AND MAINTENANCE INSTRUCTIONS IN THE OWNER'S MANUAL WITH THIS UNIT.

IMPORTANT:

For your protection in the event of theft or loss of this LC color video projector, please record the Model Number and Serial Number located on the rear of unit and retain this information. Refer to these numbers whenever you call upon your Eiki dealer regarding this product.

Model No: LC-100

Serial No: _____

IMPORTANT SAFETY INSTRUCTIONS

Read all of the instructions given here and retain them for later use. Unplug this projector from AC power supply before cleaning. Do not use liquid or aerosol cleaners. Use a damp cloth for cleaning.

Do not use attachments not recommended by the manufacturer as they may cause hazards.

Do not place this projector on an unstable cart, stand, or table. The projector may fall, causing serious injury to a child or adult, and serious damage to the projector. Use only with a cart or stand recommended by the manufacturer, or sold with the projector. Wall or shelf mounting should follow the manufacturer's instructions, and should use a mounting kit approved by the manufacturer.

Do not expose this unit to rain or use near water... for example, in a wet basement, near a swimming pool or the like.

Slots and openings in the cabinet and the back or bottom are provided for ventilation, to insure reliable operation of the equipment and to protect it from overheating.

The openings should never be covered with cloth or other material, and the bottom opening should not be blocked by placing the projector on a bed, sofa, rug, or other similar surface. This projector should never be placed near or over a radiator or heat register.

This projector should not be placed in a built-in installation such as a bookcase unless proper ventilation is provided.

This projector should be operated only from the type of power source indicated on the marking label. If you are not sure of the type of power supplied, consult your Eiki dealer or local power company.

Do not overload wall outlets and extension cords as this can result in fire or electric shock. Do not allow anything to rest on the power cord. Do not locate this projector where the cord will be abused by persons walking on it.

Never push objects of any kind into this projector through cabinet slots as they may touch dangerous voltage points or short out parts that could result in a fire or electric shock. Never spill liquid of any kind on the projector.

Do not attempt to service this projector yourself as opening or removing covers may expose you to dangerous voltage or other hazards. Refer all servicing to qualified service personnel.

Unplug this projector from wall outlet and refer servicing to qualified service personnel under the following conditions:

- a. When the power cord or plug is damaged or frayed.
- b. If liquid has been spilled into the projector.
- c. If the projector has been exposed to rain or water.
- d. If the projector does not operate normally by following the operating instructions. Adjust only those controls that are covered by the operating instructions as improper adjustment of other controls may result in damage and will often require extensive work by a qualified technician to restore the projector to normal operation.
- e. If the projector has been dropped or the cabinet has been damaged.
- f. When the projector exhibits a distinct change in performance - this indicates a need for service.

When replacement parts are required, be sure the service technician has used replacement parts specified by the manufacturer that have the same characteristics as the original part. Unauthorized substitutions may result in fire, electric shock, or injury to persons.

Upon completion of any service or repairs to this projector, ask the service technician to perform routine safety checks to determine that the projector is in safe operating condition.

AC 120V version only.

This projector is equipped with a polarized AC line plug. Should you be unable to insert the plug into the outlet, contact your electrician. Do not defeat the safety purpose of this polarized plug.



Follow all warnings and instructions marked on the projectors.

For added protection for the projector during a lightning storm, or when it is left unattended and unused for long periods of time, unplug it from the wall outlet. This will prevent damage due to lightning and powerline surges.



An appliance and cart combination should be moved with care. Quick stops, excessive force, and uneven surfaces may cause the appliance and cart combination to overturn.

TABLE OF CONTENTS		page	page
Safety Precautions	1	Picture Adjustment	10
Important Safety Instructions	2	Temp. Monitor and Lamp	
Terminology of Parts	3	Replacement	11
Installation	4 ~ 6	Maintenance	12
Operating Procedure	7	Trouble Shooting Guide	13
Connection Procedure	8 ~ 9	Specifications	13

TERMINOLOGY OF PARTS For details refer to the page number given in the box

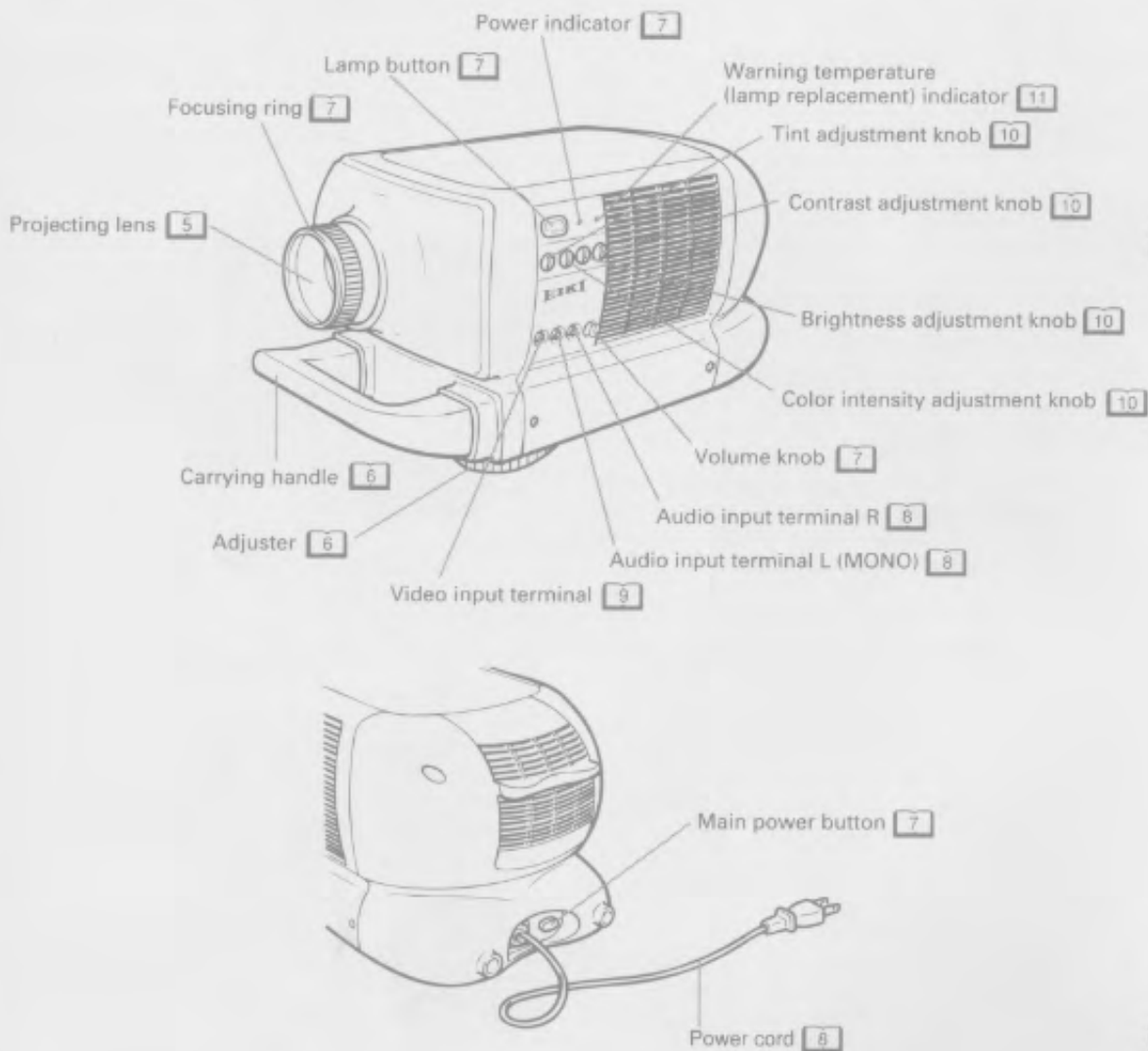

INSTALLATION

Installation

- Position the screen so that sunlight and illuminating rays do not fall on the screen directly. If light falls on the screen directly, it becomes white and the picture cannot be seen clearly. In brightly lit rooms, pull down the shades or the curtains.
- A correct picture will be obtained on the screen when the projector and screen are set perpendicular to each other. Set the projector and the screen as shown in the illustrations below.

Top view

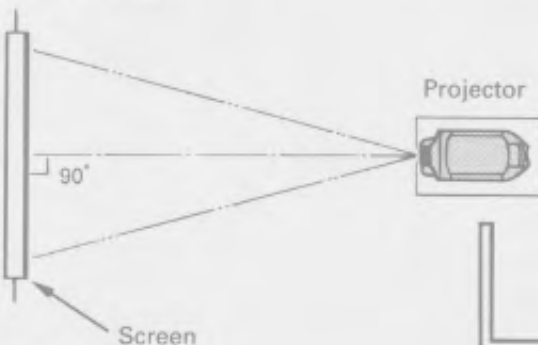

Side view

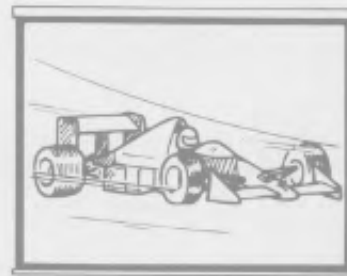
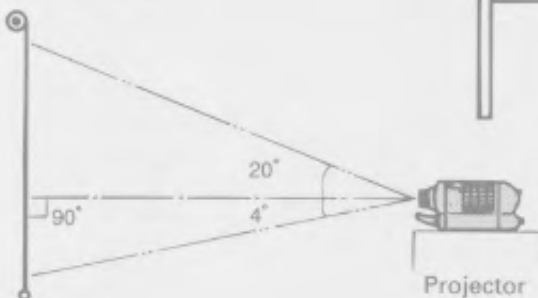

Correct picture is obtained on the screen.

- If the projector and the screen are not set correctly, the picture on the screen will be distorted and difficult to see.

Caution!

- Do not install the projector in a humid or dusty location or in a place where fumes or cigarette smoke may come into contact with it. Otherwise, dirt or other foreign matter may stick on the lens and optical parts, and the picture will become distorted and dark.
- Do not install in very hot or very cold locations. (Admissible operating temperature range 5°C~35°C. Admissible storage temperature range -20°C~50°C.)
- The sides and rear panel of the projector have exhaust ports for the cooling fan. Therefore, place the projector at least 30 cm away from the wall.

Adjusting the screen size

Adjust the projection distance and the height of the projector stand to suit the size of the screen.

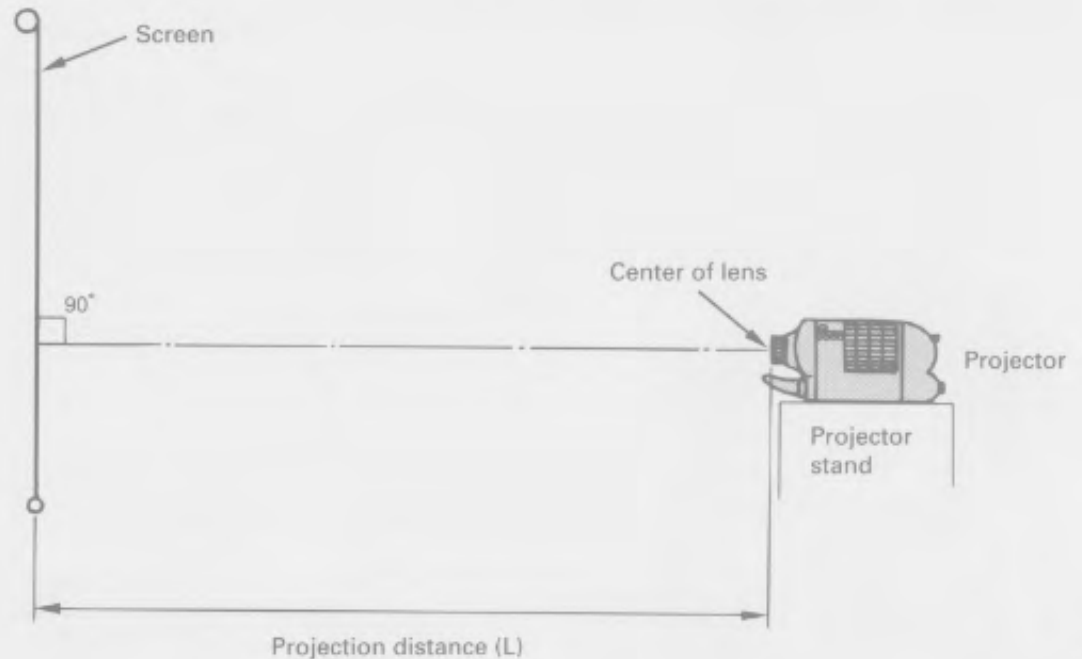

Screen size (Diagonal)	Projection distance (L)	Screen dimensions Width × Height
100 inches	11'(3.4 m) approx.	80" × 60" (203 × 152 cm)
80 inches	8.9'(2.7 m) approx.	65" × 48" (163 × 122 cm)
60 inches	6.6'(2.0 m) approx.	48" × 36" (122 × 91 cm)
40 inches	4.2'(1.3 m) approx.	32" × 24" (81 × 61 cm)

Caution!

- If you place the projector on a soft object or material, the ventilation to the projector will be poor. Place the projector on a stand that allows good ventilation.
- A metal halide lamp is used in the projector. Therefore, never place the projector on its sides or incline it to the left or right, during use. Otherwise, the life of the lamp will be significantly reduced. Also, do not use the projector to project a picture on the ceiling. Therefore, do not point it at the ceiling.
- In addition, please read the safety precautions given on Page 1 and the important safety instructions on Page 2, before you install the projector.

To increase the height of projection

You can increase the height of projection by adjusting the height adjuster at the base of the projector.

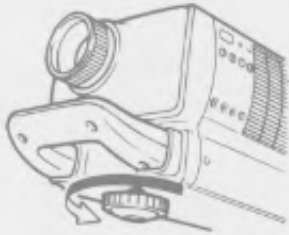

If you rotate the adjuster counter-clockwise, the projector rises.

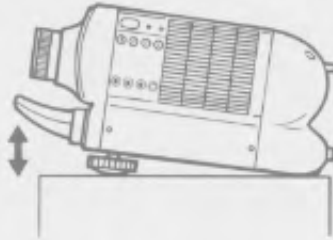

You can adjust the angle between 4 and 10 degrees.

- After use, rotate back to the low position.
- The screen may become distorted when you use the adjuster for adjustments, because of the relative positions of the projector and screen.

Moving the projector

Hold the carrying handle, lift the projector and then move it.

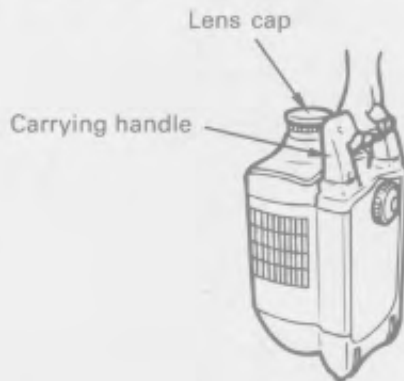

Precautions when moving the projector

- Do not move the projector when the lamp is lit.
- Cover the lens with the lens cap and protect it before you move the projector.

Make sure that the cooling fan is OFF before you move the projector after use.

- If you disconnect the power cord and move the projector while the cooling fan is operating, the internal components may be damaged.

OPERATING PROCEDURE

Preparations

- Switch on the equipment connected to the projector and input the audio signal and video signal to the projector.
- Remove the lens cap from the projector.

Operation

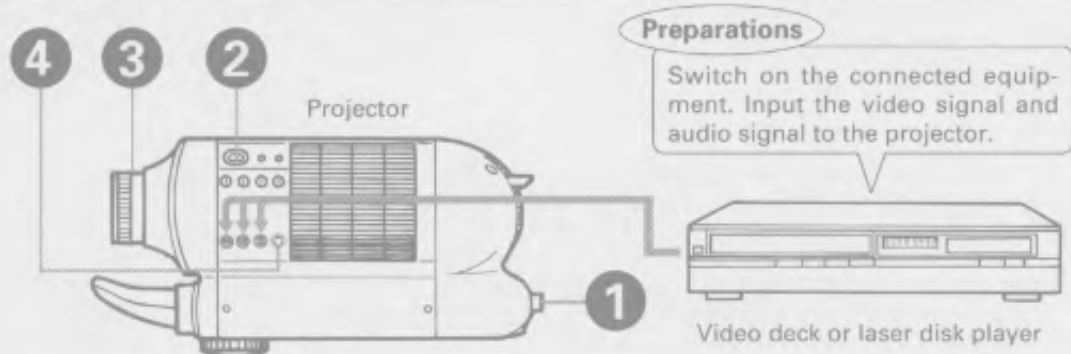

1 Switch on the main power.

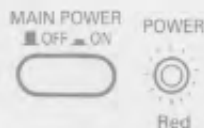

Press the main power button.
Power indicator lights up in red.

- To switch off the main power, press the main power button again.

2 Switch on the power.

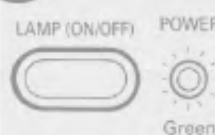

Press the lamp button.
The lamp lights up.
The power indicator changes from red to green.

The power indicator flashes on and off before coming on fully. When you see it flashing, simply wait for it to come on.

- To switch off the power, press the power button again.

3 Adjust the focus.



Adjust the focusing ring while observing the picture on the screen, until you obtain a sharp image.

4 Adjust the volume of the built-in speaker.



Rotate the sound volume knob to set the desired sound level.

- + : Sound becomes loud.
- : Sound becomes low.

Caution!

- The lamp may extinguish if the projector is subjected to an external shock while it is ON. Do not subject the projector to any shock or impact, or move the projector while the lamp is ON.
- The cooling fan in the projector rotates when the temperature in the projector is high, even if you switch off the power. When the fan is rotating, never switch off the main power or disconnect the power cord from the socket.

CONNECTION PROCEDURE

Before connection

- To protect the projector and the connecting equipment, turn the power "OFF" before you connect the video equipment.
- Do not place the projector on top of the video equipment (video deck or laser disk player).
- Refer to the instruction manuals for the equipment for details of connection before using the equipment.
- Pin terminals are provided for video and audio terminals. Purchase the connecting cord from the dealer nearest to your shop.

Connection of power cord

Make sure you connect the power cord to a 120 V AC domestic socket. (110 V AC in some area)

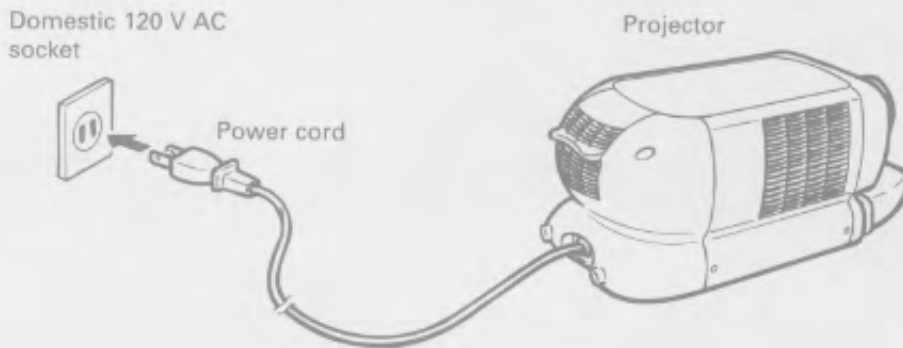

Connection of audio cord

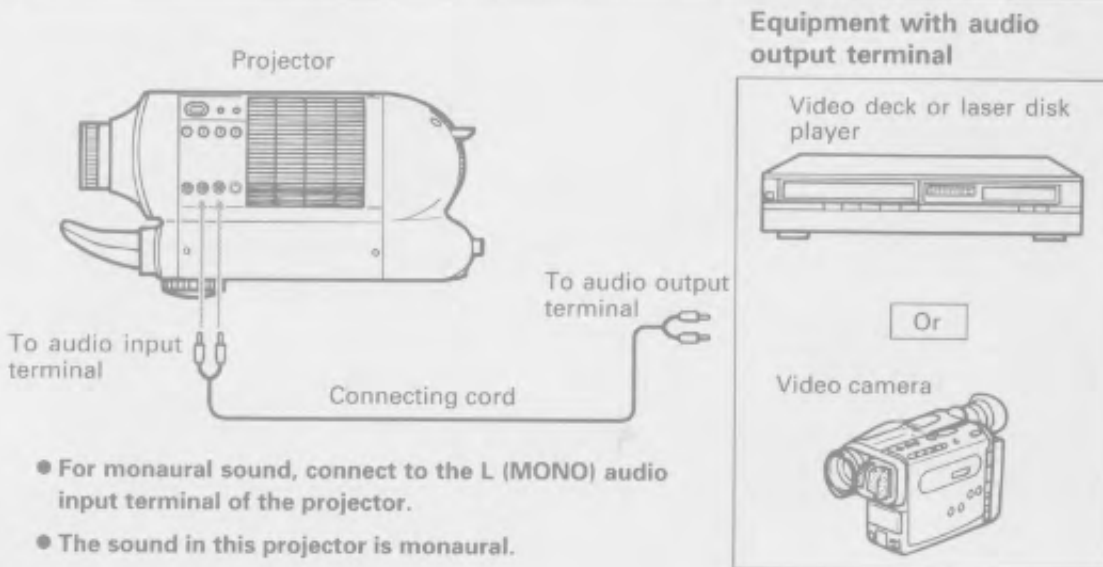

- For monaural sound, connect to the L (MONO) audio input terminal of the projector.
- The sound in this projector is monaural.

Connection of video cord

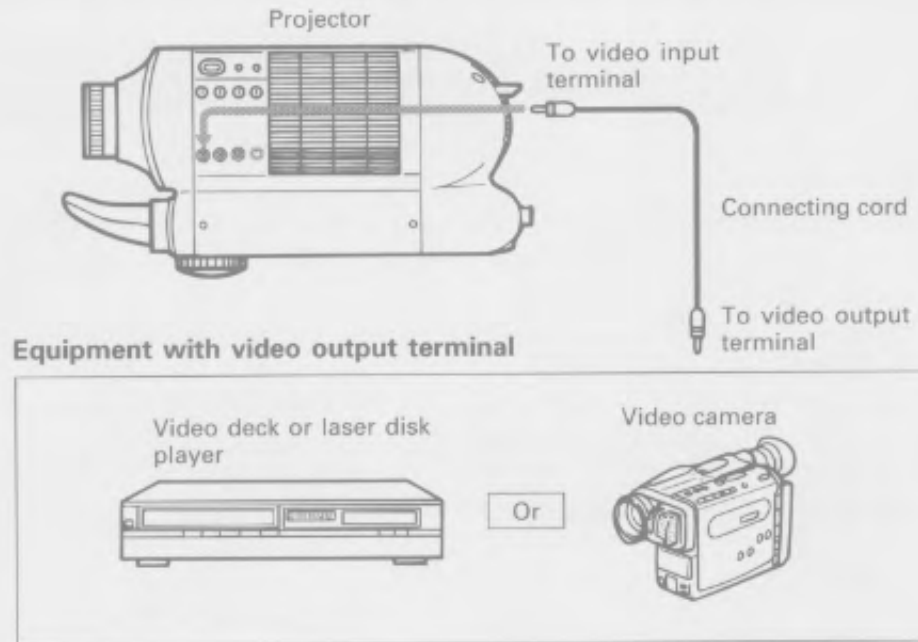

Connection to audio system

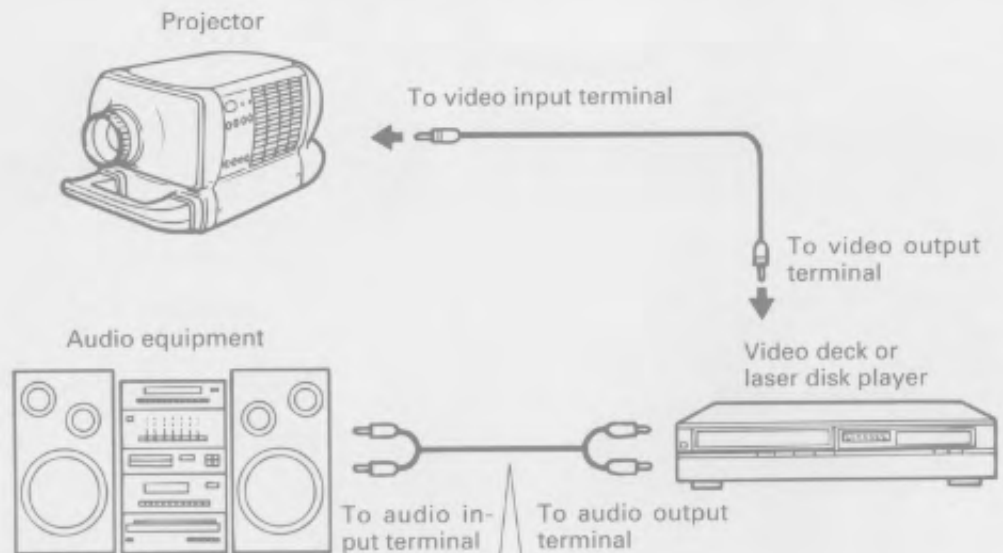

Audio connecting cord

Connect the audio signal cord from the video equipment to the audio input terminal of the audio equipment.

PICTURE ADJUSTMENT

The standard picture adjustment levels (tint, color intensity, brightness, contrast) are set when the groove on each knob is vertical. Adjust them as required.

- If you insert a coin in the groove in the center of a knob, you can adjust it more easily.

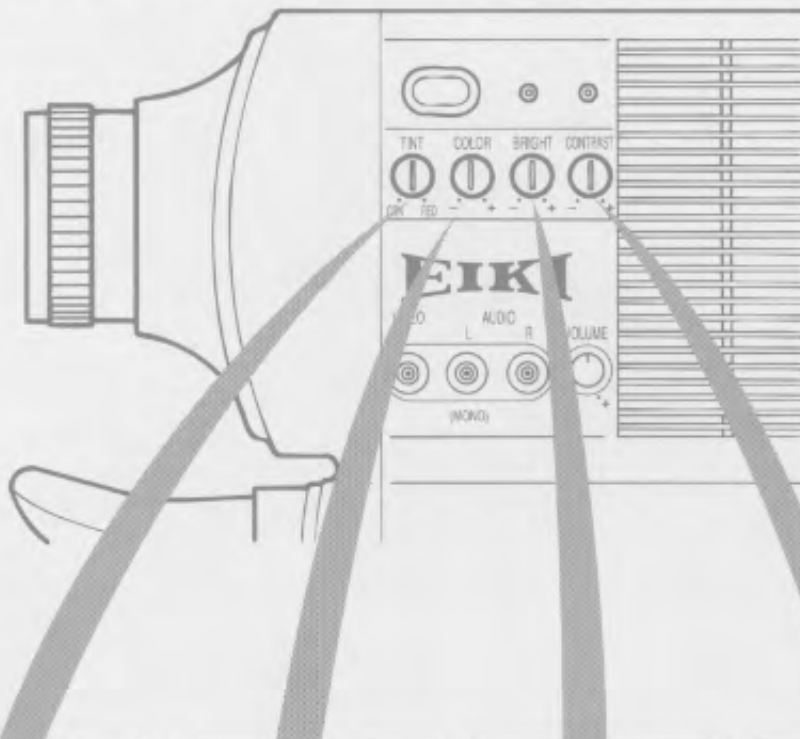

TINT adjustment knob



Adjust this knob so that the tint is natural.

GRN : The tint becomes greenish if you rotate the knob counter-clockwise.

RED : The tint becomes reddish if you rotate the knob clockwise.

Color intensity adjustment knob



Adjust to obtain the desired color intensity.

- : The color becomes light if you rotate this knob counter-clockwise.

+ : The color becomes dark if you rotate this knob clockwise.

Brightness adjustment knob



Adjust this knob to suit the light of the surroundings, so that the picture is clearly visible.

- : The picture becomes dark if you rotate the knob counter-clockwise.

+ : The picture becomes bright if you rotate the knob clockwise.

Contrast adjustment knob



Adjust this knob to obtain the desired contrast.

- : A soft image is obtained if you rotate this knob counter-clockwise.

+ : Bold image is obtained if you rotate this knob clockwise.

TEMP. MONITOR AND LAMP REPLACEMENT

There is an indicator on the projector that shows the temperature rise within the projector and lamp replacement interval .

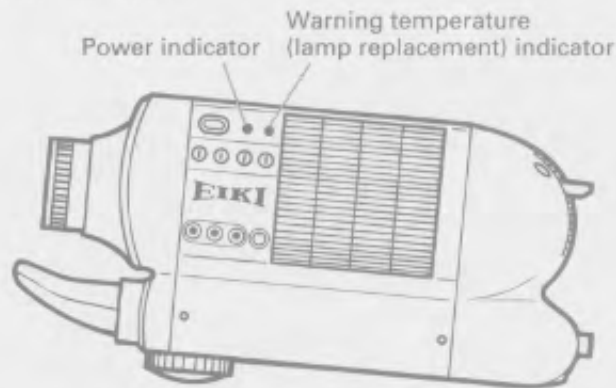

Adopt necessary measures after observing the lighting status of the power indicator and warning temperature (lamp replacement) indicator.

Warning temperature (lamp replacement) indicator	Meaning	Action
Lights up in red	<ul style="list-style-type: none"> ● The temperature inside the unit has increased. For safety, the power will be cut off. ● When the temperature decreases, the warning temperature (lamp replacement) indicator goes off. While the warning temperature (lamp replacement) indicator is on, you cannot turn the power indicator lamp on, even by using the power button. ● If you want to turn the power indicator lamp on, make sure that the warning temperature (lamp replacement) indicator is not lit, then press the power button. 	<ul style="list-style-type: none"> ● The temperature inside the unit has increased. If the ventilation slot (air-intake and out-take) is obstructed, remove the obstruction and let the unit cool down. ● If the warning temperature (lamp replacement) indicator is still lit, even after the above action has been taken, please consult your nearest dealer.
Lights up in orange	<ul style="list-style-type: none"> ● The metal halide lamp which is used as a light source is nearly worn out. The metal halide lamp requires replacement. ● There is a failure in the metal halide lamp. The metal halide lamp requires replacement. 	<ul style="list-style-type: none"> ● Please obtain a replacement metal halide lamp from your dealer.

Caution!

Request for lamp replacement.

- Contact the dealer from which you bought the projector, in order to get the lamp replaced.
- Never open the projector cover. This is dangerous because there are high voltage parts within the projector.

MAINTENANCE

Clean the projector once a year.

- If dust collects in the projector, it may lead to a breakdown. Once a year, clean the internal parts of the projector.

To clean the internal parts of the projector, contact the dealer from which you bought the projector.

Lens maintenance

- Clean the lens using a blower or lens cleaning paper (used for cleaning spectacle lenses or camera lenses) - these are widely available in shops. The lens may be damaged easily, therefore do not clean the lens using a hard object or strike it with a hard object.

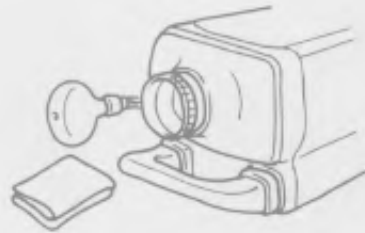

Maintenance of the set

- Make sure you use a soft, dry cloth for cleaning the projector. If the projector is very dirty, soak a soft cloth in dilute soap solution, wring it dry and wipe off the dirt. Then, use a dry cloth and wipe it again. If you use a chemical cloth, make sure you read the accompanying precautions.



- Avoid using volatile liquids such as benzene, thinner or alcohol for cleaning the projector. Do not spray insecticides in the vicinity of the projector. Otherwise, the material may change or the paint may peel off. Also, do not keep the projector in contact with rubber or plastic items for a long period.



- Remove dust and dirt from the air filter regularly using a vacuum cleaner. Clean the air filter frequently, particularly in locations where a lot of dust gathers.

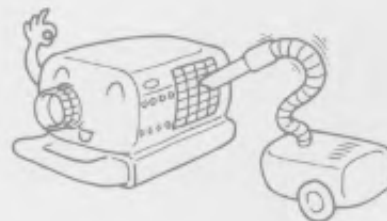

TROUBLE SHOOTING GUIDE

Check the points mentioned below. If the fault remains, do not repair by yourself. Contact the dealer from which you bought the projector.

Symptoms	Check these points.
No power	<ul style="list-style-type: none"> ● Is the power cord plug correctly inserted in the socket? ● Is the main power switch ON?
No picture	<ul style="list-style-type: none"> ● Are the positions of picture adjustment knobs (Tint, color intensity, brightness, contrast) correct? ● Are the connections between the video equipment and projector correct? ● Is the video signal being input to the projector? ● Is the light source lamp off?
No sound	<ul style="list-style-type: none"> ● Is the sound volume adjustment knob turned right down (to "—")? ● Is the connection (audio) with the video equipment correct? ● Did you operate the video equipment to input the audio signal to the projector?
Picture is fuzzy.	<ul style="list-style-type: none"> ● Has the lens been focused correctly?
Colors are not natural.	<ul style="list-style-type: none"> ● Are the positions of the picture adjustment knobs (Tint, color intensity, brightness, contrast) correct?

SPECIFICATIONS

Model	LC-100	Video input	1.0 Vpp 75 ohms unbalanced (pin jack) × 1
Projection system	One liquid crystal panel, 3-base color shutter system	Audio input	0.1 Vrms 600 ohms (pin jack) × 2
Liquid crystal panel	Panel size: 4 inches Number of panels : 1 Drive system : TFT active matrix type No. of Pixels : 112,086	Permissible operating temperature	5 °C ~ 35 °C
		Permissible relative humidity	Less than 80%
Projecting lens	Focal length: 5-5/16 in (135 mm) Aperture : F2.8 Lens configuration : 3 glass lenses in 3 groups	Storage temperature	-20 °C ~ 50 °C
		Power supply	AC 120 V, 60 Hz (AC110V in some area)
		Power consumption	185 W approx.
Lamp (light source)	Metal halide lamp 150 W	Dimensions (W) × (H) × (D)	19-9/16 × 9-1/16 × 9-1/4 in (497 × 230 × 236 mm)
Internal Speaker	1-9/16" (4cm) × 2-3/4" (7cm) oval	Weight	17 lbs 7 oz (7.9 kg) approx.
Internal Speaker Power Output	Monaural, 2W RMS (THD 10%)	Accessories	Lens cap

- The design and the specifications are subject to change without notice because of continual improvements.

EIKI

Audio Visual/Video Products

EIKI INTERNATIONAL, INC.

26794 Vista Terrace Drive Lake Forest, CA 92630-8113
TEL (714) 457-0200 FAX (714) 457-7878

IN CANADA, EIKI CANADA

101 Thorncliffe Park Drive, Toronto, Ont. M4H 1M2
TEL (416) 467-1161 FAX (416) 467-6070